

KOINO Company Profile **02**

Control Switch **06**

Proximity Sensor **22**

Photo Sensor **28**

PM Sensor **32**

Limit Switch KL **34**

Limit Switch 8005 **38**

Micro Switch **40**

Cam Switch **46**

Foot Switch **52**

Buzzers **54**

Relay **58**

Sockets **60**

Signal Light **62**

KFS Series - Floatless Switch **64**

MISC. **65**



**DEKO TECH.**

Tel: +98 21 4440 5248      +98 21 4445 6384

Fax: +98 21 4385 1355      Mobile: 0912 175 9529

E-mail: [info@deko-co.com](mailto:info@deko-co.com)      [www.dekopart.com](http://www.dekopart.com)

# KUN HUNGELECTRIC SINCE 1969

## Who we are?

Kunhung Electric Co., Ltd. established since 1969, is a leading professional manufacturer of industrial control equipment. With more than 45 years of experience in the industry, Kunhung understands the needs and requirements of our customers, and we are striving for the highest level of customer service and satisfaction. We have manufactured products with KS, NT, EM, CCC and UL.

## Quality System & Safety Standards

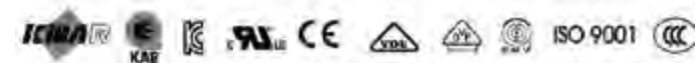

GREATIVE PASSION



**DEKO TECH.**

Tel: +98 21 4440 5248      +98 21 4445 6384  
Fax: +98 21 4385 1355    Mobile: 0912 175 9529  
E-mail: [info@deko-co.com](mailto:info@deko-co.com)    [www.dekopart.com](http://www.dekopart.com)

## Our Customers:



**PHOTO MICRO SENSOR**  
Display panel testing equipment for iPhone 6 – KPS-M23



**PHOTO MICRO SENSOR**  
SMT Machine - Substituted list:OMRON(EE-SX674 / EE-SX672A / EE-SX670A) SUNX (PM-L24 / PM-F24)  
Position control robot



**PROXIMITY SENSOR, PHOTO SENSOR**  
Beijing Metro gate - KPS-CTVN (SET) over 15,000 pcs / year Metro Ticketing machine - KPS-Z2DN



**PROXIMITY SENSOR, PHOTO SENSOR**  
Construct machine, vehicle by DOOSAN INFRACORE  
IPX-D12-05E1N IPX-D18-08E1N IPX-D12-05E2N IPX-D30-10E1D-  
Seach 10,000 pcs / year(for 15 years)



**CONTROL SWITCH – FLUSH MOUNTING TYPE, EMERGENCY STOP SWITCH**  
Post collecting machine control – KOREA POST SERVICE



**CONTROL SWITCH – EMERGENCY STOP SWITCH**  
Forklift truck – DOOSAN INFRACORE  
Packing machine-Emergency switch, NF22 Pushbutton switch, Selector switch

**MANUFACTURING**

# CONTROL SWITCH Ø 25mm / 30mm

# Ø 25mm / 30mm CONTROL SWITCH

## FLUSH MOUNTING TYPE

### NF30(25)G W - L M 1C R 1 1 Z

	①	②	③	④	⑤	⑥	⑦	⑧
① BEZEL	NONE	Alluminum Bezel						
	G	Plastic Bezel						
② PROTECTION	NONE	IP40						
	W	IP54						
③ CATEGORY	L	Pilot Lamp						
	P	PushButton Switch						
	B	Illuminated PushButton Switch						
	S	Selector Switch						
	K	Key Selector Switch						
④ ACTUATOR	M	Momentary						
	A	Alternate						
	2	2 Steps Maintained Lever						
	3	3 Steps Maintained Lever						
	A2	2 Steps Spring Return Lever						
	A3	3 Steps Spring Return Lever						
⑤ INPUT-VOLTAGE	3R	3 Steps-Left:Maintained, Right:spring return						
	1A	110VAC 50/60Hz						
	2A	220VAC 50/60Hz						
	1C	6VDC						
	2C	12VDC						
⑥ COLOR	3C	24VDC						
		Red, Green, Yellow, Blue, White, Orange						
⑦ CONTACT	Number	Numbers of NO Contact						
	Number	Numbers of NC Contact						
⑧ CONTACT BLOCK	none	General type Contact block						
	Z	Snap action type Contact block						

## PUSH BUTTON SWITCH

### KPB - 30(25) W M - R 1 1

	①	②	③	④	⑤
① PROTECTION	NONE	IP40			
	W	IP65			
	M	PushButton, Momentary			
② ACTUATOR	AT	PushButton, Maintained			
	EM	Mushroom Headed Push-Button, Momentary			
	EA	Mushroom Headed Push-Button, Maintained			
	ER	PushButton, Turn To Reset			
	EP	PushButton, Pull To Reset			
③ COLOR		Red, Green, Yellow, Blue, White, Black			
④ CONTACT	NUMBER	Number of NO Contact			
⑥ CONTACT	NUMBER	Number of NO Contact			

## Features

Ø 25/ 30 Control Switching Gear and Pilot Lamp  
 Long service life, low maintenance  
 Space saving miniature style  
 Various illumination colors: red, green, yellow, blue- and white  
 Black or metallic flush bezels available.



## ILLUMINATED PUSH BUTTON SWITCH

### KBL - 30(25) W M - L 1C R 1 1

	①	②	③	④	⑤	⑥	⑦
① PROTECTION	NONE	IP40					
	W	IP65					
② PROTECTION	M	PushButton, Momentary					
	MP	PushButton Protective Ring, Momentary					
	AT	PushButton, Maintained					
	AP	PushButton Protective Ring, Maintained					
	EM	Mushroom Headed PushButton, Momentary					
	EA	Mushroom Headed PushButton, Maintained					
	ER	Mushroom Headed PushButton, Turn To Reset					
③ LAMP	EP	Mushroom Headed PushButton, Pull To Reset					
	NONE	Filament Lamp					
	L	LED Lamp					
	B	Illuminated PushButton Switch					
	S	Selector Switch					
④ INPUT VOLTAGE	K	Key Selector Switch					
	1A	110VAC AT 50/60 Hz					
	2A	220VAC AT 50/60 Hz					
	3A	230VAC AT 50/60 Hz					
	1C	6V AC/DC					
	2C	12V AC/DC					
	3C	24 AC/DC					
⑤ COLOR		Red, Green, Yellow, Blue, White, Orange					
⑥ CONTACT	NUMBER	Number of NO Contact					
⑦ CONTACT	NUMBER	Number of NC Contact					



## SELECTOR SWITCH

### KSL - 30(25) W S2 - R 1 1

	①	②	③	④	⑤
① PROTECTION	NONE	IP40			
	W	IP65(except illuminated model)			
② ACTUATOR	S2	2 STEPS Maintained, short knob			
	S3	3 STEPS Maintained, short knob			
	AS2	2 STEPS Spring Return, short knob			
	AS3	3 STEPS Spring Return, short knob			
	RS3	3 STEPS L:MANUAL, R:SPRING, short knob			
	L2	2 STEPS Maintained, long knob			
	L3	3 STEPS Maintained, long knob			
	AL2	2 STEPS Spring Return, long knob			
	AL3	3 STEPS Spring Return, long knob			
	③ LAMP COLOR	RL3	3 STEPS L:MANUAL, R:SPRING, long knob		
RK3		3 STEPS L:MANUAL, R:SPRING, key			
R		RED			
④ CONTACT	G	GREEN			
	Y	YELLOW			
	1A	110VAC AT 50/60 Hz			
⑤ CONTACT	2A	220VAC AT 50/60 Hz			
	No.	Number of NO Contact			
⑥ CONTACT	No.	Number of NC Contact			

## PILOT LAMP

### KPL - 30(25) W - L 1C R

	①	②	③	④
① PROTECTION	NONE	IP40		
	W	IP65		
② LAMP	NONE	Filament Lamp		
	L	LED Lamp		
③ INPUT VOLTAGE	1A	110VAC AT 50/60 Hz		
	2A	220VAC AT 50/60 Hz		
	3A	230VAC AT 50/60 Hz		
	1C	6V AC/DC		
	2C	12V AC/DC		
④ LAMP COLOR	3C	24V AC/DC		
		Red, Green, Yellow, Blue, White, MilkyWhite, Orange		



## PUSH BUTTON SWITCH

	Ø 25	Ø 30	ACTUATOR
	KPB25M	KPB30M	PUSH BUTTON, MOMENTARY
	KPB25WM	KPB30WM	
	KPB25AT	KPB30AT	PUSH BUTTON, MAINTAINED
	KPB25WAT	KPB30WAT	
	KPB25EM	KPB30EM	PUSH BUTTON, MOMENTARY
	KPB25WEM	KPB30WEM	
	KPB25EA	KPB30EA	PUSH BUTTON, MAINTAINED
	KPB25WEA	KPB30WEA	
	KPB25ER	KPB30ER	PUSH BUTTON, TURN TO RESET
	KPB25WER	KPB30WER	
	KPB25EP	KPB30EP	PUSH BUTTON, PULL TO RESET
	KPB25WEP	KPB30WEP	
	KPB25MS	KPB30MS	SELECTABLE PUSH BUTTON
	KPB25ML	KPB30ML	

## SELECTOR SWITCH

	Ø 25	Ø 30	ACTUATOR
	KSL25S2	KSL30S2	2 Steps, Maintained
	KSL25WS2	KSL30WS2	
	KSL25S3	KSL30S3	3 Steps, Maintained
	KSL25WS3	KSL30WS3	
	KSL25AS2	KSL30AS2	2 Steps, Spring Return
	KSL25WAS2	KSL30WAS2	
	KSL25AS3	KSL30AS3	3 Steps, Spring Return
	KSL25WAS3	KSL30WAS3	
	KSL25RS3	KSL30RS3	3 Steps L:maintained, R:Spring return
	KSL25WRS3	KSL30WRS3	
	KSL25L2	KSL30L2	2 Steps, Maintained
	KSL25WL2	KSL30WL2	
	KSL25L3	KSL30L3	3 Steps, Maintained
	KSL25WL3	KSL30WL3	
	KSL25AL2	KSL30AL2	2 Steps, Spring Return
	KSL25WAL2	KSL30WAL2	
	KSL25AL3	KSL30AL3	3 Steps, Spring Return
	KSL25WAL3	KSL30WAL3	
	KSL25RL3	KSL30RL3	3 Steps L:maintained, R:Spring return
	KSL25WRL3	KSL30WRL3	
	KSL25K2	KSL30K2	2 Steps, Maintained
	KSL25WK2	KSL30WK2	
	KSL25K3	KSL30K3	3 Steps, Maintained
	KSL25WK3	KSL30WK3	
KSL25AK2	KSL30AK2	2 Steps, Spring Return	
KSL25WAK2	KSL30WAK2		
	KSL25AK3	KSL30AK3	3 Steps, Spring Return
	KSL25WAK3	KSL30WAK3	
	KSL25RK3	KSL30RK3	3 Steps L:maintained, R:Spring return
	KSL25WRK3	KSL30WRK3	

**PILOT LAMP**

	Ø 25	Ø 30	INPUT VOLTAGE
	KPL25-1, 2, 3 A	KPL30-1, 2, 3 A	110, 220, 230 VAC with Trans
	KPL25W-1, 2, 3 A(IP65)	KPL30W-1, 2, 3 A(IP65)	
	KPL25-1, 2, 3 C	KPL30-1, 2, 3 C	6, 12, 24 VDC without trans
	KPL25W-1, 2, 3 C(IP65)	KPL30W-1, 2, 3 C(IP65)	

**ILLUMINATED PUSH BUTTON SWITCH**

	Ø 25	Ø 30	INPUT VOLTAGE
	KBL25M KBL25AT KBL25WM KBL25WAT	KBL30M KBL30AT KBL30WM KBL30WAT	110, 220, 230 VAC with Trans
			6, 12, 24 VDC without trans
	KBL25MP KBL25ATP KBL25WMP KBL25WATP (Protective Ring)	KBL30MP KBL30ATP KBL30WMP KBL30WATP (Protective Ring)	110, 220, 230 VAC with Trans
			6, 12, 24 VDC without trans
	KBL25EM KBL25EA KBL25EP KBL25EWM KBL25EWA KBL25EWP	KBL30EM KBL30EA KBL30EP KBL30EWM KBL30EWA KBL30EWP	110, 220, 230 VAC with Trans
			6, 12, 24 VDC without trans
	KBL25ER KBL25WER	KBL30ER KBL30WER	110, 220, 230 VAC with Trans
			6, 12, 24 VDC without trans

**FLUSH MOUNTING TYPE**

	Ø 25	Ø 30	
	NF25-L-1A, 2ANF25-L-1C, 2C, 3C	NF30-L-1A, 2A NF30-L-1C, 2C, 3C	
	NF25-P NF25-PA	NF30-PNF 30-PA	
	NF25-B-1A, 2A NF25-B-1C, 2C, 3C	NF30-B-1A, 2ANF 30-B-1C, 2C, 3C	
	NF25-S	NF30-S	
	NF25-K	NF30-K	
	NF25G-L-1A, 2A NF25G-L-1C, 2C, 3C	NF30G-L-1A, 2A NF30G-L-1C, 2C, 3C	
	NF25G-PNF NF25G-PA	NF30G-P NF30G-PA	
	NF25G-B-1A, 2A NF25G-B-1C, 2C, 3C	NF30G-B-1A, 2A NF30G-B-1C, 2C, 3C	
	NF25G-S	NF30G-S	
	NF25G-K	NF30G-K	

# CONTROL SWITCH Ø 22mm

# Ø 22mm CONTROL SWITCH

## PUSH BUTTON SWITCH

**KH - 2201 AT - 1 1 R**

① ②③④

① ACTUA-TOR	NONE	Momentary
	AT	Maintained
	EB	Mushroom Head
	ER	Emergency Stop
	S	Selectable Push button
② CONTACT	Number of Contact	
③ CONTACT	Number of Contact	
④ COLOR	Red, Green, Yellow, Blue, White, Black	

### Features

Ø 22 Control Switching Gear and Pilot Lamp  
 Long service life, low maintenance  
 Space saving miniature style  
 Various illumination colors:red, green, yellow, blue and white  
 Black or metallic flush bezels available.



## SELECTOR SWITCH

**KH - 2202 2S - 1 1**

① ② ③

① ACTUA-TOR	2S	2 Steps Maintained / Short Knob
	3S	3 Steps Maintained / Short Knob
	2L	2 Steps Maintained / Long Knob
	3L	3 Steps Maintained / Long Knob
	2AS	2 Steps Spring Return / Short Knob
	3AS	3 Steps Spring Return / Short Knob
	3RS	3 Steps / Left: Maintained, Right: Spring Return / Short Knob
	2AL	2 Steps Spring Return / Long Knob
	3AL	3 Steps Spring Return / Long Knob
	3RL	3 Steps/Left:Maintained, Right: Spring Return/Long Knob
	2K	2 Steps Maintained / KEY Switch
	3K	3 Steps Maintained / KEY Switch
	2AK	2 Steps Spring Return / KEY Switch
	3AK	3 Steps Spring Return / KEY Switch
	3RK	3 Steps / Left:Maintained, Right:Spring Return / KEY Switch
② CONTACT	Number of NO Contact	
③ CONTACT	Number of NC Contact	

## PILOT LAMP

**KH - 2203 L - 1 R**

① ②③

① LAMP	NONE	Filament Lamp
	L	LED
② INPUT VOLT-AGE	1	110VAC 50/60 Hz
	2	220VAC 50/60 Hz
	3	230VAC 50/60 Hz
	TL	6, 12, 24 AC / DC
	③ COLOR	R



## ILLUMINATED PUSH BUTTON SWITCH

**KH - 2204 L P - 2 - 1 1 - R**

①② ③ ④⑤ ⑥

① Lamp	NONE	Filament Lamp
	L	LED Lamp
② ACTUA-TOR	NONE	Momentary
	AT	Maintained
	P	Momentary / Protective Ring
	AP	Maintained / Protective Ring
	EB	Momentary / Mushroom Head
③ INPUT VOLTAGE	ER	Maintained / Turn-to reset / Mushroom Head
	1	110VAC 50 / 60Hz
	2	220VAC 50 / 60Hz
	3	230VAC 50 / 60Hz
④ CONTACT	TL	6, 12, 24 AC / DC
④ CONTACT	Number of NO Contact	
⑤ CONTACT	Number of NC Contact	
⑥ COLOR	Red, Green, Yellow, Blue, White, MilkyWhite	





## FLUSH MOUNTING TYPE

**NF22 - L M - 1C R 1**

①② ③ ④⑤

① CATE-GORY	L	Pilot Lamp	
	P	Push Button switch	
	B	Illuminated Push Button switch	
	S	Selector Switch	
② ACTUA-TOR	K	Key Switch	
	M	Momentary	For Push Button Switch
	A	Maintained	
	2	2 Steps Maintained	For Selector Switch
	3	3 Steps Maintained	
A2	2 Steps Spring Return		
A3	3 Steps Spring Return		
③ INPUT VOLTAGE	1C	6V	
	2C	12V	
	3C	24V	
④ COLOR	Red, Green, Yellow, Blue, White MilkyWhite, Orange		
⑤ CON-TACT	1	1C	
	2	2C	

**PUSH BUTTON SWITCH**

	ITEM NUMBER	ACTUATOR
	KH-2201	Push Button(Momentary / Maintained)
	KH-2201AT	
	KH-2201EB	Push Button
	KH-2201ER	Maintained / Turn-to reset
	KH-2201S	Selectable Push Button









**SELECTOR SWITCH**

	KH-2202-2S/3S	Short Knob
	KH-2202-2AS/3AS	
	KH-2202-3RS	
	KH-2202-2L/3L	Long Knob
	KH-2202-2AL/3AL	
	KH-2202-3RL	
	KH-2202-2K/3K	Key Switch
	KH-2202-2AK/3AK	
	KH-2202-3RK	



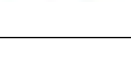

**PILOT LAMP**

	KH-2203-1/2/3	Filament, Trans
	KH-2203L-1/2/3	LED, Trans
	KH-2203-TL	Filament, without Trans
	KH-2203L-TL	LED, Trans, without Trans

**ILLUMINATED PUSH BUTTON SWITCH**

	ITEM NUMBER	ACTUATOR	ITEM NUMBER	
	KH-2204-1/2	Illuminated Push Button (with Trans)	KH-2204EB-1/2/3	
	KH-2204AT-1/2		KH-2204LEB-1/2/3	
	KH-2204L-1/2			
	H-2204-TL	Illuminated Push Button (without Trans)	KH-2204EB-TL	
	KH-2204AT-TL		KH-2204LEB-TL	
	KH-2204L-T			
	KH-2204LAT-TL			
	KH-2204ER-1/2/3	Push/Turn to reset	KH-2204ER-TL	
KH-2204ERL-1/2/3	KH-2204LER-TL			
	KH-2204P-1/2	Illuminated Push Button (Protective Ring)	KH-2204P-TL	
	KH-2204AP-1/2		KH-2204AP-TL	
	KH-2204LP-1/2		KH-2204LP-TL	
	KH-2204LAP-1/2		KH-2204LAP-TL	

**FLUSH MOUNTING TYPE**

	NF22-L	Pilot Lamp
	NF22-P	Push Button
	NF22-B	Illuminated Push Button
	NF22-S	Selector Switch
	NF22-K	Key Switch



# CONTROL SWITCH Ø 16mm

# Ø 16mm CONTROL SWITCH

## KH-516 SERIES

KH-516 - A 1 2 - R (12)	
① ② ③ ④ ⑤	
① SHAPE	A: Square
	B: Rectangle
	C: Round
	D: Emergency Stop
② FUNCTION	0: Pilot Lamp
	1: Illuminated PushButton Switch(Momentary)
	2: Illuminated PushButton Switch(Maintained)
	3: PushButton Switch(Momentary)
	4: PushButton Switch(Maintained)
③ CONTACTS	0: Pilot Lamp only
	1: 1C(1A1B)
	2: 2C(2A2B)
④ COLOR	Red, Green, Yellow, Blue, Orange
⑤ INPUT VOLTAGE	6V, 12V, 24V

### Features

Ø 16 Control Switching Gear and Pilot Lamp  
 Long service life, low maintenance  
 Space saving miniature style  
 Various illumination colors:red, green, yellow, blue and white.



## PUSH BUTTON SWITCH

KPB16 S M - R 1		
① ② ③ ④		
① SHAPE	NONE	NONE Ø18mm Round Head
		0 Ø25mm Round Head Flush Mounting Type
		1 Ø25mm Round Head
		S Square
② ACTUATOR	R	Rectangle
	M	Momentary
③ COLOR	AT	Maintained
	R	Red, Green, Yellow, Orange, White, Blue
④ CONTACTS	1	1C
	2	2C

## PILOT LAMP

KPL16 S - L 1C R		
① ② ③ ④		
① SHAPE	NONE	NONE Ø18mm Round Head
		s Ø25mm Round Head Flush Mounting Type
		R Ø25mm Round Head
		S Square
② LAMP	R	Rectangle
	NONE	Filament
③ INPUT VOLTAGE	L	LED
	1C	6V
	2C	12V
④ COLOR	3C	24V
		Red, Green, Yellow, Orange, White, Blue







## SELECTOR SWITCH





KSL16 S S2 - L 1C R 1		
① ② ③ ④ ⑤ ⑥		
① SHAPE	NONE	round
	S	Square
	R	Rectangle
② ACTUATOR	S2	2 Steps Manual Return
	AS2	2 Steps Spring Return
	S3	3 Steps Manual Return
	AS3	3 Steps Spring Return
	K2	2 Steps Manual Return with key
	AK2	2 Steps Spring Return with key
	K3	3 Steps Manual Return with key
③ Lamp	AK3	3 Steps Spring Return with key
	NONE	NO Lamp
	F	Filament Lamp
④ INPUT VOLTAGE	L	LED Lamp
	1C	6V
	2C	12V
⑤ LAMP COLOR	3C	24V
		Red, Green, Yellow, Orange, White, Blue
⑥ CONTACTS	1	1C
	2	2C

## ILLUMINATED PUSH BUTTON SWITCH

KBL16 S M - L 1C R 1		
① ② ③ ④ ⑤ ⑥		
① SHAPE	NONE	Ø18mm Round Head
	0	Ø25mm Round Head, FlushType
	1	Ø25mm Round Head
	S	Square
② ACTUATOR	R	Rectangle
	M	Momentary
③ LAMP	AT	Maintained
	NONE	Filament
④ INPUT VOLTAGE	L	LED
	1C	6V
	2C	12V
⑤ COLOR	3C	24V
		Red, Green, Yellow, Orange, White, Blue
⑥ CONTACTS	1	1
	2	2C

**KH-516 SERIES**

APPEAR- ANCE	PUSH BUTTON	PUSH BUTTON MAINTAINED	ILLUMINATED PUSH BUTTON	ILLUMINATED PUSHBUTTON- MAINTAINED	PILOT LAMP	Emergency Stop
	KH-516-C31 KH-516-C32	KH-516-C41 KH-516-C42	KH-516-C11 KH-516-C12 KH-516L-C11 KH-516L-C12	KH-516-C21 KH-516-C22 KH-516L-C21 KH-516L-C22	KH-516-C00 KH516L-C00	N/A
	KH-516-A31 KH-516-A32	KH-516-A41 KH-516-A42	KH-516-A11 KH-516-A12 KH-516L-A11 KH-516L-A12	KH-516-A21 KH-516-A22 KH-516L-A21 KH-516L-A22	KH-516-A00 KH516L-A00	N/A
	KH-516-B31 KH-516-B32	KH-516-B41 KH-516-B42	KH-516-B11 KH-516-B12 KH-516L-B11 KH-516L-B12	KH-516-B21 KH-516-B22 KH-516L-B21 KH-516L-B22	KH-516-B00 KH516L-B00	N/A
	N/A	N/A	N/A	N/A	N/A	KH-516-D32 KH-516-D32 KH-516-D41 KH-516-D42

	KPB 16M	Momentary	PUSH BUTTON SWITCH
	KPB 16AT	Maintained	
	KPB 160M	Momentary	
	KPB 160AT	Maintained	
	KPB 161M	Momentary	
	KPB 161AT	Maintained	
	KPB 16SM	Momentary	
	KPB 16SAT	Maintained	
	KPB 16RM	Momentary	
	KPB 16RAT	Maintained	



	KSL 16S2	2 steps Manual Return	PUSH BUTTON SWITCH
	KSL 16AS2	2 steps Spring Return	
	KSL 16S3	3 steps Manual Return	
	KSL 16AS3	3 steps Spring Return	
	KSL 16SS2	2 steps Manual Return	
	KSL 16SAS2	2 steps Spring Return	
	KSL 16SS3	3 steps Manual Return	
	KSL 16SAS3	3 steps Spring Return	
	KSL 16RS2	2 steps Manual Return	
	KSL 16RAS2	2 steps Spring Return	
	KSL 16RS3	3 steps Manual Return	
	KSL 16RAS3	3 steps Spring Return	
	KSL 16K2	2 steps Manual Return	
	KSL 16AK2	2 steps Spring Return	
	KSL 16K3	3 steps Manual Return	
	KSL 16AK3	3 steps Spring Return	
	KSL 16SK2	2 steps Manual Return	
	KSL 16SAK2	2 steps Spring Return	
	KSL 16SK3	3 steps Manual Return	
	KSL 16SAK3	3 steps Spring Return	
	KSL 16RK2	2 steps Manual Return	
	KSL 16RAK2	2 steps Spring Return	
	KSL 16RK3	3 steps Manual Return	
	KSL 16RAK3	3 steps Spring Return	

	KPL 16	LED Lamp	PILOT LAMP
	KPL 160	LED Lamp	
	KPL 161	LED Lamp	
	KPL 16S	LED Lamp	
	KPL 16R	LED Lamp	

	KBL 16M	Momentary	ILLUMUNATED PUSH BUTTON SWITCH
	KBL 16AT	Maintained	
	KPB 160M	Momentary	
	KBL 160AT	Maintained	
	KBL 161M	Momentary	
	KBL 161AT	Maintained	
	KBL 16SM	Momentary	
	KBL 16SAT	Maintained	
	KBL 16RM	Momentary	
	KBL 16RAT	Maintained	

	KEPB 160ER	Maintained / Turn-to reset
	KEPB 160ERS	
	KEPB 22ER	
	KEPB 22ERS	
	KEPB 22ERK	

**EMERGENCY STOP SWITCH (New Model)  
Direct Opening Mechanism EN60947-5-1**

	KEPB 16ER	Maintained / Turn-to reset
	KEBL 16ER'	

# PROXIMITY SWITCH – IPX SERIES

# PROXIMITY SWITCH

## CLASSIFICATION

IPX - □ □ - □ □ □ □ □ □			
① ② ③ ④ ⑤ ⑥ ⑦			
① Type	A		AC 2-Wire Model
	D		DC 3-Wire Model
	2D		DC 2-Wire Model
② Shape/ Size	Cylindrical	12	Ø12
		18	Ø18
		30	Ø30
	Rectangular	17	□17mm
		25	□25mm
		30	□30mm
		40	□40mm
③ Sensing Distance	number	Rated sensing distance(Sn)	
④ Control output	E1	DC 3-wire model	NPN NO
	E2		NPN NC
	E3		PNP NO
	E4		PNP NC
	A1	AC 2-Wire Model DC 2-Wire Model	NO
	A2		NC
⑤ ConnectionMethod	none	Pre-wired	
	R	Connector	
	W	Wired connector	
	S	Pre-wired(rectangular model)	
⑥ Shielding	none	Shielded	
	N	Unshielded	
⑦ Polarity	F	No polarity	
	none	Polarity	



### Features

- Variety – 2 wire DC, 3 wire DC, 2 wire AC, shielded/non-shielded models, connectorized or cable out, M12 to M30 sizes
- Reliability – protected from short circuits, voltage surges, polarity reversal and current overload
- Degree of Protection:IP67
- Declaration of conformity:CE

DIAMETER		Ø12		Ø18		Ø30	
PRE-WIRED MODEL							
SENSING DISTANCE		2.0mm ±10%	4.0mm ±10%	5.0mm ±10%	8.0mm ±10%	10.0mm ±10%	15.0mm ±10%
TYPE		Shielded	Unshielded	Shielded	Unshielded	Shielded	Unshielded
DC 3 WIRE	NPN NO	IPX-D12-02E1	IPX-D12-04E1N	IPX-D18-05E1	IPX-D18-08E1N	IPX-D30-10E1	IPX-D30-15E1N
	NPN NC	IPX-D12-02E	IPX-D12-04E2N	IPX-D18-05E2	IPX-D18-08E2N	IPX-D30-10E2	IPX-D30-15E2N
	PNP NO	IPX-D12-02E3	IPX-D12-04E3N	IPX-D18-05E3	IPX-D18-08E3N	IPX-D30-10E3	IPX-D30-15E3N
	PNP NC	IPX-D12-02E4	IPX-D12-04E4N	IPX-D18-05E4	IPX-D18-08E4N	IPX-D30-10E4	IPX-D30-15E4N
DC 2 WIRE	POLAR NO	IPX-2D12-02A1	IPX-2D12-04A1N	IPX-2D18-05A1	IPX-2D18-08A1N	IPX-2D30-10A1	IPX-2D30-15A1N
	POLAR NC	IPX-2D12-02A2	IPX-2D12-04A2N	IPX-2D18-05A2	IPX-2D18-08A2N	IPX-2D30-10A2	IPX-2D30-15A2N
	NON-POLAR NO	IPX-2D12-02A1F	IPX-2D12-04A1NF	IPX-2D18-05A1F	IPX-2D18-08A1NF	IPX-2D30-10A1F	IPX-2D30-15A1NF
	NON-POLAR NC	IPX-2D12-02A2F	IPX-2D12-04A2NF	IPX-2D18-05A2F	IPX-2D18-08A2NF	IPX-2D30-10A2F	IPX-2D30-15A2NF
AC 2 WIRE	NO	IPX-A12-02A1	IPX-A12-04A1N	IPX-A18-05A1	IPX-A18-05A1N	IPX-A30-10A1	IPX-A30-10A1N
	NC	IPX-A12-02A	IPX-A12-04A2N	IPX-A18-05A2	IPX-A18-05A2N	IPX-A30-10A2	IPX-A30-10A2N

DIAMETER		Ø12		Ø18		Ø30	
WIRE-CONNECTOR MODEL							
SENSING DISTANCE		2.0mm ±10%	4.0mm ±10%	5.0mm ±10%	8.0mm ±10%	10.0mm ±10%	15.0mm ±10%
TYPE		Shielded	Unshielded	Shielded	Unshielded	Shielded	Unshielded
DC 3 WIRE	NPN NO	IPX-D12-02E1W	IPX-D12-04E1WN	IPX-D18-05E1W	IPX-D18-08E1WN	IPX-D30-10E1W	IPX-D30-15E1WN
	NPN NC	IPX-D12-02E2W	IPX-D12-04E2WN	IPX-D18-05E2W	IPX-D18-08E2WN	IPX-D30-10E2W	IPX-D30-15E2WN
	PNP NO	IPX-D12-02E3W	IPX-D12-04E3WN	IPX-D18-05E3W	IPX-D18-08E3WN	IPX-D30-10E3W	IPX-D30-15E3WN
	PNP NC	IPX-D12-02E4W	IPX-D12-04E4WN	IPX-D18-05E4W	IPX-D18-08E4WN	IPX-D30-10E4W	IPX-D30-15E4WN
DC 2 WIRE	POLAR NO	IPX-2D12-02A1W	IPX-2D12-04A1WN	IPX-2D18-05A1W	IPX-2D18-08A1WN	IPX-2D30-10A1W	IPX-2D30-15A1WN
	POLAR NC	IPX-2D12-02A2W	IPX-2D12-04A2WN	IPX-2D18-05A2W	IPX-2D18-08A2WN	IPX-2D30-10A2W	IPX-2D30-15A2WN
	NON-POLAR NO	IPX-2D12-02A1WF	IPX-2D12-04A1WNF	IPX-2D18-05A1WF	IPX-2D18-08A1WNF	IPX-2D30-10A1WF	IPX-2D30-15A1WNF
	NON-POLAR NC	IPX-2D12-02A2WF	IPX-2D12-04A2WNF	IPX-2D18-05A2WF	IPX-2D18-08A2WNF	IPX-2D30-10A2WF	IPX-2D30-15A2WNF
AC 2 WIRE	NO	IPX-A12-02A1W	IPX-A12-04A1WN	IPX-A18-05A1W	IPX-A18-05A1WN	IPX-A30-10A1W	IPX-A30-10A1WN
	NC	IPX-A12-02A2W	IPX-A12-04A2WN	IPX-A18-05A2W	IPX-A18-05A2WN	IPX-A30-10A2W	IPX-A30-10A2WN

DIAMETER		Ø12		Ø18		Ø30	
CONNECTOR MODEL							
SENSING DISTANCE		2.0mm±10%	4.0mm±10%	5.0mm±10%	8.0mm±10%	10.0mm±10%	15.0mm±10%
TYPE		Shielded	Unshielded	Shielded	Unshielded	Shielded	Unshielded
DC 3 WIRE	NPN NO	IPX-D12-02E1R	IPX-D12-04E1RN	IPX-D18-05E1R	IPX-D18-08E1RN	IPX-D30-10E1R	IPX-D30-15E1RN
	NPN NC	IPX-D12-02E2R	IPX-D12-04E2RN	IPX-D18-05E2R	IPX-D18-08E2RN	IPX-D30-10E2R	IPX-D30-15E2RN
	PNP NO	IPX-D12-02E3R	IPX-D12-04E3RN	IPX-D18-05E3R	IPX-D18-08E3RN	IPX-D30-10E3R	IPX-D30-15E3RN
	PNP NC	IPX-D12-02E4R	IPX-D12-04E4RN	IPX-D18-05E4R	IPX-D18-08E4RN	IPX-D30-10E4R	IPX-D30-15E4RN
DC 2 WIRE	POLAR NO	IPX-2D12-02A1R	IPX-2D12-04A1RN	IPX-2D18-05A1R	IPX-2D18-08A1RN	IPX-2D30-10A1R	IPX-2D30-15A1RN
	POLAR NC	IPX-2D12-02A2R	IPX-2D12-04A2RN	IPX-2D18-05A2R	IPX-2D18-08A2RN	IPX-2D30-10A2R	IPX-2D30-15A2RN
	NON-POLAR NO	IPX-2D12-02A1RF	IPX-2D12-04A1RNF	IPX-2D18-05A1RF	IPX-2D18-08A1RNF	IPX-2D30-10A1RF	IPX-2D30-15A1RNF
	NON-POLAR NC	IPX-2D12-02A2RF	IPX-2D12-04A2RNF	IPX-2D18-05A2RF	IPX-2D18-08A2RNF	IPX-2D30-10A2RF	IPX-2D30-15A2RNF
AC 2 WIRE	NO	IPX-A12-02A1R	IPX-A12-04A1RN	IPX-A18-05A1R	IPX-A18-05A1RN	IPX-A30-10A1R	IPX-A30-10A1RN
	NC	IPX-A12-02A2R	IPX-A12-04A2RN	IPX-A18-05A2R	IPX-A18-05A2RN	IPX-A30-10A2R	IPX-A30-10A2RN

DIAMETER		□17mm	□25mm	□30mm	□40mm
RECTANGULAR MODEL					
SENSING DISTANCE		5.0mm ±10%	5.0mm ±10%	10.0mm ±10%	20.0mm ±10%
DC 3 WIRE	NPN NO	IPX-D12-02E1S	IPX-D12-04E1S	IPX-D18-05E1S	IPX-D18-20E1S
	NPN NC	IPX-D12-02E2S	IPX-D12-04E2S	IPX-D18-05E2S	IPX-D18-20E2S
	PNP NO	IPX-D12-02E3S	IPX-D12-04E3S	IPX-D18-05E3S	IPX-D18-20E3S
	PNP NC	IPX-D12-02E4S	IPX-D12-04E4S	IPX-D18-05E4S	IPX-D18-20E4S
DC 2 WIRE	POLAR NO	IPX-2D17-05A1S	IPX-2D25-05A1S	IPX-2D30-10A1S	IPX-2D40-20A1S
	POLAR NC	IPX-2D17-05A2S	IPX-2D25-05A2S	IPX-2D30-10A2S	IPX-2D40-20A2S
	NON-POLAR NO	IPX-2D17-05A1SF	IPX-2D25-05A1SF	IPX-2D30-10A1SF	IPX-2D40-20A2SF
	NON-POLAR NC	IPX-2D17-05A2SF	IPX-2D25-05A2SF	IPX-2D30-10A2SF	IPX-2D40-20A2SF
AC 2 WIRE	NO	-	IPX-A25-05A1S	IPX-A30-10A1S	IPX-A40-20A1S
	NC	-	IPX-A25-05A2S	IPX-A30-10A2S	IPX-A40-20A2S

# PROXIMITY SWITCH – CPX SERIES



## Features

- Capacitive proximity sensors for detecting metal and non-metal (glass, wood, water, oil, etc.)
- Reliability – protected from short circuits, voltage surges, polarity reversal and current overload
- Degree of Protection : IP67

## CLASSIFICATION

CPX - □ □ - □ □ □					
	①	②	③	④	⑤
① Type	D	DC 3-wire model			
② Diameter	18	Ø18mm			
	30	Ø30mm			
③ Sensing distance	08	8mm			
	15	15mm			
④ Control output	E1	NPN NO			
	E2	NPN NC			
⑤ Shield	N	Unshielded			

Ø18	CPX-D18-08E1N	
	CPX-D18-08E2N	
Ø30	CPX-D30-15E1N	
	CPX-D30-15E2N	

# PROXIMITY SWITCH – KPX SERIES





## Features

- Proximity sensors for detecting metals.
- Small size: Ø4, Ø8 mm diameter available
- Degree of Protection: IP67





Ø4	KPX-D04-X8E□M	
Ø8	KPX-D08-01E□M	
	KPX-D08-02E□M	

# PHOTO SENSOR

## KPS-CT SERIES

	ITEM NUMBER	TYPE	SENSING DISTANCE	INPUT VOLTAGE	FEATURE
	KPS-CTV (Vertical)		1.5M	12~24VDC	Small size photo sensor Through- Wbeam type IP-Rating:IP40
	KPS-CTH (Horizontal)				

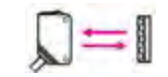





## KPS-Z SERIES

	ITEM NUMBER	TYPE	SENSING DISTANCE	INPUT VOLTAGE	FEATURE
	KPS-ZT		1.5M	12~24VDC	Small size photo sensor Light on & Dark on
	KPS-ZTS				
	KPS-ZRN		3M	12~24VDC	Small size photo sensor Light on & Dark on
	KPS-ZRNS				
	KPS-Z2DN		1M	12~24VDC	Small size photo sensor Light on & Dark on
	KPS-ZDNS		0.5M		



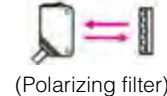

# PHOTO SENSOR







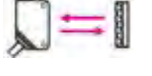

## KPS-AL SERIES

	ITEM NUMBER	TYPE	SENSING DISTANCE	INPUT VOLTAGE	FEATURE
	KPS-AL		10M	AC/DC 24~240V	Small size photo sensor Light on & Dark on
	KPS-ALTR		5M		
	KPS-ALTP	 (Polarizing filter)	3M		
	KPS-ALD		1M		



**KPS-AR SERIES**

ITEM NUMBER	TYPE	SENSING DISTANCE	INPUT VOLTAGE	FEATURE
 KPS-AR500		5M	AC/DC 24~240V	Small size photo sensor-Light on & Dark on
 KPS-AR-250TR		2.5M		
 KPS-AR-40DR		0.6M		



**KPS-AP SERIES**

ITEM NUMBER	TYPE	SENSING DISTANCE	INPUT VOLTAGE	FEATURE
 KPS-AP500		5M	110VAC: 88~121VAC	Zinc Alloy Die Cast
 KPS-AP-500TR		5M		
 KPS-AP-50DR		0.5M		



**KPS-P SERIES**

ITEM NUMBER	TYPE	SENSING DISTANCE	POWER CONSUMPTION	INPUT VOLTAGE	FEATURE
 KPS-P300S		0.5~5m (Adjustable)	APPROX. 2.5 VA	110~220VAC (50/60Hz)	Suitable for collision prevention-Can use both relay output and TR outputCan adjust detection range with gain control knobOverload protection circuit
KPS-P300DAS			100mA maximum	12VDC	
KPS-P300DBS			24VDC		
KPS-P300DS			12~24VDC		

**KPS-CP CONTROLLER**

 KPS-CP012	100~110VAC 200~220VAC (50/60Hz)	APPROX. 3.5 VA	Proximity sensor, Photo sensor available.Relay output
 KPS-CP024		APPROX. 3.5 VA	

**REFLECTOR**





Model	Housing	Reflector	Weight
 KPS-RF-S3	 KPS-R3	 KPS-RF	
KPS-RF	Fe	Acryl (transparent)	90g
KPS-R3	ABS (Black)	Acryl (transparent)	24g
KPS-RF-S3	ABS (Black)	Acryl (transparent)	24g



# PHOTO MICRO SENSOR





## Features

- Ultra Small Package and Small Package available
- Equipped with two independent outputs
- 5 types of design configuration
- Built-in overcurrent protection circuit
- Built-in Reverse polarity and Output error connection protection circuit

Type		Output	Model No.	
Ultra-small Package (KPS-M2 Series)	K Type	NPN Output	KPS-M20	
		PNP Output	KPS-M20P	
	L Type	NPN Output	KPS-M21	
		PNP Output	KPS-M21P	
	F Type	NPN Output	KPS-M22	
		PNP Output	KPS-M22P	
	R Type	NPN Output	KPS-M23	
		PNP Output	KPS-M23P	
	U Type	NPN Output	KPS-M24	
		PNP Output	KPS-M24P	

# PHOTO MICRO SENSOR



Type		Output	Model No.	
Small Package (KPS-M6 Series)	K Type	NPN Output	KPS-M60	
		PNP Output	KPS-M60P	
	L Type	NPN Output	KPS-M61	
		PNP Output	KPS-M61P	
	T Type	NPN Output	KPS-M62	
		PNP Output	KPS-M62P	
	F Type	NPN Output	KPS-M63	
		PNP Output	KPS-M63P	
	Y Type	NPN Output	KPS-M64	
		PNP Output	KPS-M64P	

# LIMIT SWITCH

## Features

- Housing is made of durable aluminum die-casting.
- Heat-resistance, oil-resistance, vibration-resistance structure (protection IP67)
- Built-in double-pole double-break standard micro-switches
- Operation Indicator (LED or Neon lamp) helps easier inspection and maintenance
- Microload models are available

KL □ - □□□□  
 ① ②③④⑤

## CLASSIFICATION

① Code	Actuator
CA2	Roller lever (75° actuation)
CA2-2	Roller lever (90° actuation)
CA12	Adjustable roller lever (75° actuation)
CA12-2	Adjustable roller lever (90° actuation)
CL	Adjustable rod lever (75° actuation)
CL-2	Adjustable rod lever (90°actuation)
CA32-41~44	Fork lever lock
D	Top plunger
D2	Top roller plunger
D28	Sealed top roller plunger
D3	Top ball plunger
SD2	Side roller plunger
NJ	Coil spring
NJ-A2	Coil spring aluminum rod

# LIMIT SWITCH



② INDICATOR	
-	NONE
LD	LED
LE	LEON LAMP

③ OPERATION TEMP.	
-	-10°C ~ +80°C
T	-40°C ~ +120°C

Can be applied to roller lever type, adjustable roller lever type and adjustable rod lever type only

④ LEVER TYPE	
-	Standard
SA	Forged lever(Aluminum)
SS	STS lever
S50	S lever(Roller O.D. Ø50)
SA50	Forged lever(Roller O.D. Ø50)

⑤ SEAL CONNETOR	
SC-D6SW	Seal connector(DC)
SC-A6SW	Seal connector(DC)

Model No.	STANDARD	LAMP INDICATOR
KLCA2(75° Max.) KLCA2-2(90° Max.) Roller lever		
KLCA12(75° Max.) KLCA12-2(90° Max.) Adjustable roller lever		
KLCL(75° Max.) KLCL-2(90° Max.) Rod lever		
KLD Top plunger		
KLD2 Top roller plunger		
KLD28 Sealed top roller plunger		

Model No.	STANDARD	LAMP INDICATOR
KLD3 Top ball plunger		
KLSD2 Side roller plunger		
KLNJ Coil spring		
KLNJ-A2 Coil spring with Aluminum rod		
KLCA32-41 KLCA32-42 KLCA32-43 KLCA32-44 Fork roller lever		
		

# LIMIT SWITCH

## Features

- Housing is made of durable aluminum die-casting.
- Heat-resistance, oil-resistance, vibration-resistance structure(Protection IP55)
- Built-in double-pole double-break standard micro-switches



KH - 80 05 - S		
① ②		
① CONTACT RATING	5	250VAC, 5A(RESISTANCE LOAD)
② ACTUATOR	S	ROLLER LEVER
	C	ADJUSTABLE ROLLER LEVER
	R	ROD LEVER
	P	PUSH PLUNGER
	PR	ROLLER PLUNGER
	CPR	CROSS-ROLLER PLUNGER
	SR	COIL SPRING

# LIMIT SWITCH



MODEL	OF(MAX.)	RF(min.)	PT	MD(MAX.)	OT(min.)	TT(min.)	MATERIAL
KH-8005-S	600g	50g	15°±5°	10°	75°	90°	Body, head: zinc-alloy die-casting Cover, roller: nylon glass Lever: Stainless steel
KH-8005-C	800g	50~21g	15°±5°	10°	75°	90°	Body, head: zinc-alloy die-casting Cover: nylon glass Rod: Stainless steel
KH-8005-R	800~203g	50~12g	15°±5°	10°	75°	90°	Body, head: zinc-alloy die-casting Cover: nylon glass Rod: Stainless steel
KH-8005-P	900g	150g	2.0mm±1.0	0.7mm	4mm	4.5mm	Body, head: zinc-alloy die-casting Cover: nylon glass Shaft: free-cutting steel
KH-8005-PR, KH-8005-CPR	900g	150g	1.5mm±0.5	0.7mm	4mm	5.5mm	Body, head: zinc-alloy die-casting Cover: nylon glass Roller : Stainless steel
KH-8005-SR	90g	-	10mm±5	-	20mm	20°	Body, head: zinc-alloy die-casting Cover: nylon glass Spring lever: Stainless steel

# MICRO SWITCH

# MICRO SWITCH

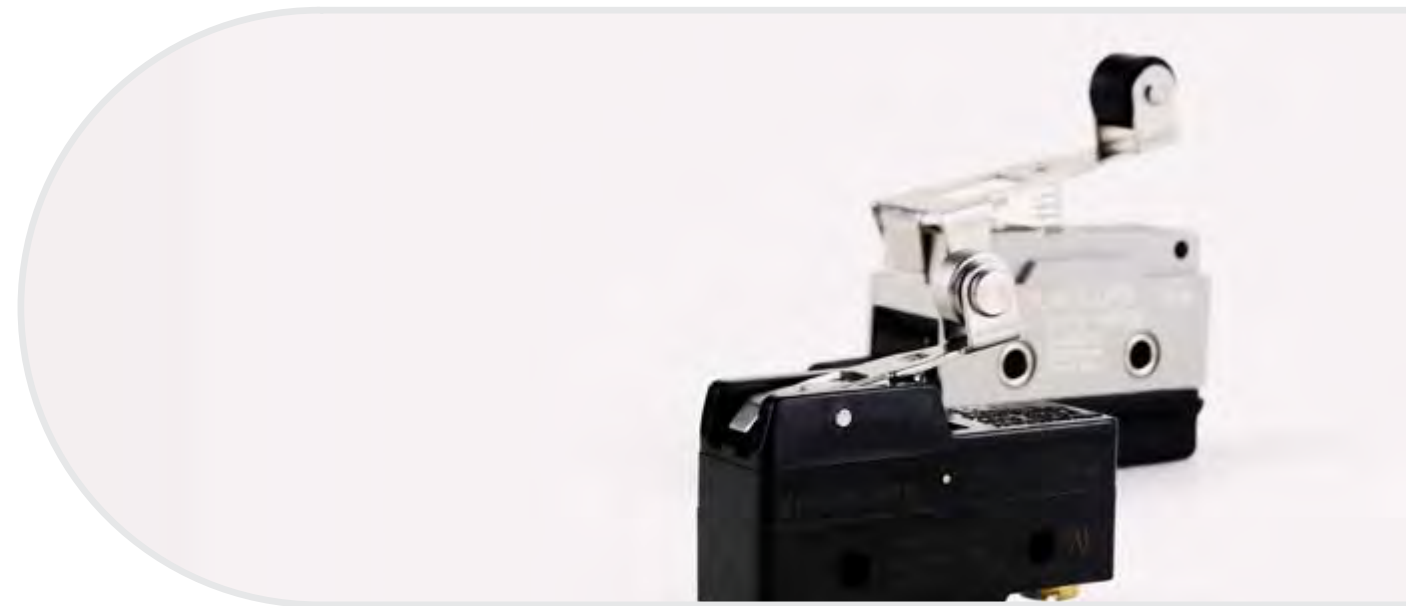











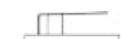

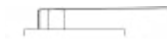

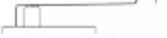



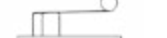



**KH - 901** □ - □ □ □ □ □  
 ①      ② ③      ④

① Code	
9012	Micro switch Type V
9015	Micro switch Standard type
9016	Compact Micro switch

② CONTACT RATING	
NONE	125VAC, 15A (Resistance load)
5	125VAC, 5A (Resistance load)

④ Contact	
NONE	None
C	Tap contact

③ ACTUATOR					
PB	Pin plunger		PBF	Slim spring plunger	
HL	Short hinge lever		PBL	Panel mount plunger	
HLL	Long hinge lever		RP	Panel mount roller plunger	
HLR	Hinge lever Round type		CRP	Panel mount cross roller plunger	
HRL	Long hinge roller lever		PBS	Short spring plunger	
HRM	Hinge roller lever		HP	Leaf spring	
HRS	Short hinge roller lever		HLZ	Hinge lever Z type	
			HR(S)W	Hinge roller lever W type	

KH-9012 series	Model No.	Contact Rating	Protection
	KH-9012-PBC KH-9012-5PBC Pin plunger	KH-9012  Rated Voltage      Rated Current 125VAC              15A Resistive 250VAC             10A Resistive 8VDC                 15A 14VDC                15A 30VDC                6A 125VDC              0.6A 250VDC              0.3A  KH-9012-5  Rated Voltage      Rated Current 125VAC              5A Resistive 250VAC              3A Resistive 8VDC                 5A 14VDC                5A 30VDC                5A 125VDC              0.6A 250VDC              0.3A	IP40
	KH-9012-HLC KH-9012-5HLC Short hinge lever		
	KH-9012-HLLC KH-9012-5HLLC Long hinge lever		
	KH-9012-HRLC KH-9012-5HRLC Long hinge roller lever		
	KH-9012-HRMC KH-9012-5HRMC Hinge roller lever		
	KH-9012-HRSC KH-9012-5HRSC Short hinge roller lever		
	KH-9012-HLRC KH-9012-5HLRC Hinge lever Round type		
	KH-9012-PBFC KH-9012-5PBFC Pin plunger		

KH-9015 series	Model No.	Contact Rating	Protection
	KH-9015-PBF Slim spring plunger	Rated Voltage      Rated Current 600VAC              3A Resistive 250VAC              10A Resistive 125VAC              115A Resistive 8VDC                 15A 14VDC                15A 30VDC                6A 125VDC              0.4A 250VDC              0.2A	IP50
	KH-9015-PBL Panel mount plunger		
	KH-9015-PBS Short spring plunger		
	KH-9015-RP Panel mount roller plunger		
	KH-9015-HP Leaf spring		
	KH-9015-HL Short hinge lever		

KH-9015 series	Model No.	Contact Rating		Protection
	KH-9015-HLL Long hinge lever	<b>Rated Voltage</b> 600VAC 250VAC 125VAC 8VDC 14VDC 30VDC 125VDC 250VDC	<b>Rated Current</b> 3A Resistive 10A Resistive 15A Resistiv 15A 15A 6A 0.4A 0.2A	IP50
	KH-9015-CRP Panel mount cross roller plunger			
	KH-9015-HRL Long hinge roller lever			
	KH-9015-HRS Short hinge roller lever			
	KH-9015-HRM Medium hinge roller lever			
	KH-9015-HLZ Hinge lever Z type			
	KH-9015-HRSW Hinge roller lever W type			
	KH-9115-HRS Short hinge roller lever			

KH-9016 series	Model No.	Protection
	KH-9016-PBL Panel mount plunger	IP54
	KH-9016-RP Panel mount roller plunger	
	KH-9016-CRP Panel mount cross roller plunger	
	KH-9016-HL Short hinge lever	
	KH-9016-HLL Long hinge lever	
	KH-9016-HRL Long hinge roller lever	
	KH-9016-HRS Short hinge roller lever	

\* Contact Ratings

Rated Voltage	Resistive Load		Inductive Load		Motor Load	
	NC	NO	NC	NO	NC	NO
125VAC	15A		10A		3A	1.5A
250VAC	10A		6A		2A	1A
500VAC	3A		2A		1.5A	0.75A
8VDC	15A		10A		-	-
14VDC	15A		10A		-	-
30VDC	10A		6A		-	-
125VDC	0.6A		0.1A		-	-
250VDC	0.3A		0.05A		-	-

# CAM SWITCH

## Features

- Various optional circuits are available
- UL / cUL certification:KCR-303
- Anti-flame material for KCR-303
- Easy installation / one-touch release of contact block:KSC-22

## CLASSIFICATION

### KH-301 - □□□□ (R)

① ②

① 4 DIGIT CIRCUIT NUMBER

② none:Manual Return | R:Auto Return by spring

\* Please specify knob type (R, H, P and F type available).

### KH-302 - □-□□□□ (R)

① ② ③

① none:standard type | R:fix with ring | K:operate with Key | KL:Key Locker type

② 4 DIGIT CIRCUIT NUMBER

③ none: Manual Return | R:Auto Return by spring

\* Please specify knob type (R, H, P and F type available).

### KH-303 - □□□□ □-□

① ② ③

① 4 DIGIT CIRCUIT NUMBER

② knob type (R, H, P and F type available).

③ none:Manual operation | PL:Pull to LOCK

# CAM SWITCH



### KSC-22 - □-□□□□ H

① ② ③

① none:Manual Return | R:Auto Return | K:Key type

② 4 DIGIT CIRCUIT NUMBER

③ H type knob available

Ratings	Model
125VAC 10A 250VAC 7.5A	KH-301
125VAC 20A 250VAC 10A	KH-302, KCR-303
125VAC 15A 250VAC 10A	KSC-22



	3Φ3W	2CT	KH-301A-2	Ammeter change-over Switch
		3CT	KH-301A-33	
	3Φ4W	3CT	KH-301A-3	
	3Φ3W	2PT	KH-301V-2	Voltmeter Change-over Switch
		3PT	KH-301V-33	
	3Φ4W	3PT	KH-301V-3	
	Auto-release		KH-301C-1	Control Switch
	LOCK, Auto-release		KH-301CL-1	

	3Φ3W	2CT	KH-302A-2	Ammeter change-over Switch
		3CT	KH-302A-33	
	3Control Switch 4W	3CT	KH-302A-3	
	3Control Switch 3W	2PT	KH-302V-2	Voltmeter Change-over Switch
		3PT	KH-302V-33	
	3Control Switch 4W	3PT	KH-302V-3	
	Auto-release		KH-302C-1	Control Switch
	LOCK, Auto-release		KH-302CL-1	

	3Φ3W	2CT	KCR-303A-2	Ammeter change-over Switch
		3CT	KCR-303A-33	
	3Φ4W	3CT	KCR-303A-3	
	3Φ3W	2PT	KCR-303V-2	Voltmeter Change-over Switch
		3PT	KCR-303V-33	
	3Φ4W	3PT	KCR-303V-3	

	KSC-22	On demand, IP 65
---	--------	------------------

**Parts**

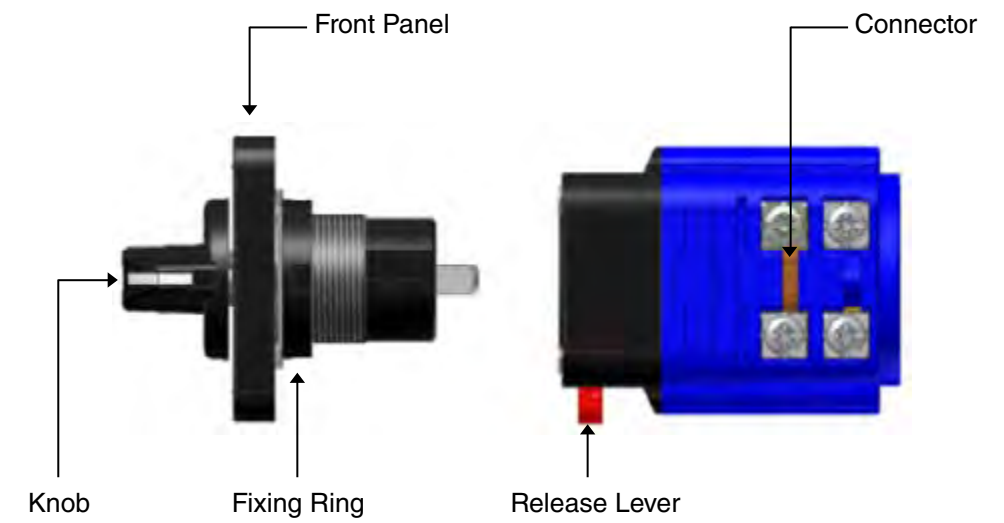

**Installation**



# FOOT SWITCH

## Features

- Internationally approved Foot Switches(industrial and specialty medical applications)
- High reliability built-in switch
- Robust enclosure

Model		Ratings	Built-in switch	Materia
KH-8016		250VAC 15A(2P)	KH-201 Contact block	Aluminum die-casting
KH-8017		125VAC 15A 14VDC 15A	KH-9015PB	
KH-8018		250VAC 15A(3P)	KH-201 Contact block	
KH-8115		125VAC 15A 14VDC 15A	KH-9015PBF	Zinc-alloy die-casting

# FOOT SWITCH

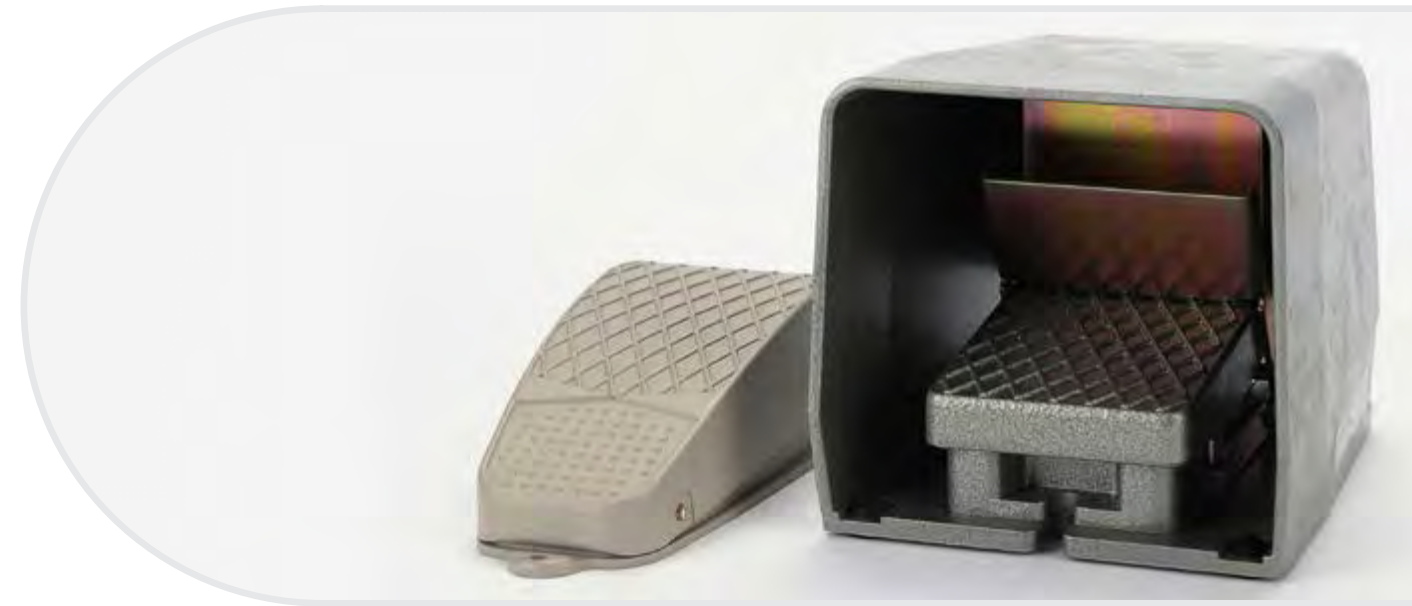

Model		Ratings	Built-in switch	Materia
KH-8012		125VAC 15A 14VDC 15A	KH-9012PBFC	ABS
KH-8013		125VAC 15A 14VDC 15A	KH-9012PBF	Aluminum die-casting
KH-8015		125VAC 15A 14VDC 15A	KH-9015PBF	

# BUZZERS



## Features

- AC / DC 12~24V
- Small size / Easy installation
- Low power consumption

Diameter	Shape	Mounting	dB(distance 1m)	Model	
Ø16	Round	Surface mounting	65dB	KH-4016	
	Square	Surface mounting		KH-4016S	
	Rectangular	Surface mounting		KH-4016R	
Ø22	Round	Surface mounting	90dB	KH-4022	
	Round	Flush mounting	65dB	NF22U	
Ø25	Round	Surface mounting	90dB	KH-4025	
Ø30	Round	Surface mounting	90dB	KH-4030	

# BUZZERS



Diameter	Mounting	Db(distance 1m)	Model	
Ø25	Surface mounting	65dB	KH-4025-1(110VAC)	
			KH-4025-2(220VAC)	
Ø30			KH-402-1(110VAC)	
			KH-402-2(220VAC)	

**KH - 403 - C F - 12**

① ② ③



① Mounting	none	Flush mounting
	C	Surface mounting
② Sound	none	Direct (AC)
	D	Direct (AC/DC)
	F	Flicker (AC/DC)
③ Input voltage	1	110VAC
	2	220VAC
	12	AC/DC 12V
	24	AC/DC 24V
	48	AC/DC 48V

**Features**

- Various melodies
- Easy installation
- Protection:IP54

Diameter for Installation	Rated Voltage	Model Number
Φ65	110/220 VAC	KH-4065A
	12/24 VDC	KH-4065D

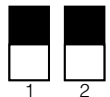
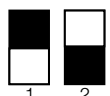
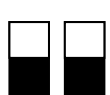
**Melody selection**

NO.	Mode	Channel					
		1	2	3	4	5	6
1(M)		Minuet	Canon	Voice of Spring	Type writer	Magic Flute	Tambourin
2(M)		Type writer	Magic Flute	Tambourin	La Campanella	Home sweet home	Swan lake
3(S)		Ambulance	Ring tone	Ding-dong	Ring-ding-dong	School bell	Door bell
4(SM)		School bell	Door bell	Home sweet home	Tambourin	Swan lake	Voice of Spring

# RELAY

# RELAY



## Features

- CCC certification
- UL certification: file No. E117960
- Operation Indicator (LED or Neon lamp) helps easier inspection and maintenance



## CLASSIFICATION

Model	Contact form	For Socket (except KH-101)		For PCB	
		W/O LED	W/ LED	W/O LED	W/ LED
KH-101	DPST NO	KH-101-2A	-	-	-
	DPDT	KH-101-2C	-	-	-
KH-102	DPDT	KH-102-2C	-	-	-
	3PDT	KH-102-3C	-	-	-
KH-103	SPDT	-	-	KH-103-1CP	KH-103-1CPL
	DPDT	KH-103-2C	KH-103-2CL	KH-103-2CP	KH-103-2CPL
	DPDT	KH-103-H2C	KH-103-H2CL	-	-
	3PDT	KH-103-3C	KH-103-3CL	KH-103-3CP	KH-103-3CPL
	4PDT	KH-103-4C	KH-103-4CL	KH-103-4CP	KH-103-4CPL

KH-101-2A		KH-101-2C	
KH-102-2C		KH-102-3C	
KH-103-1CP			
KH-103-2C		KH-103-2CP	
KH-103-3C		KH-103-3CP	
KH-103-4C		KH-103-4CP	
KH-103-H2C			

# SOCKETS



## RELAY SOCKETS

MODEL		RATINGS	MATERIAL
KH-RS-14N		250V 7A	NYLON GLASS
KH-RS-14M			
KH-RS-H2C		250V 10A	PHENOL RESIN
KH-RS-P14		250V 7A	
KH-RS-P14-8			
KH-RS-PC14			
KH-RS-PC14-8			

# SOCKETS



## 8PIN SOCKETS

MODEL		RATINGS	MATERIAL
KH-TDR-R8		250V 10A	PBT GLASS
KH-KTS-8			
KH-RS-R8			
KH-MR-8		250V 7A	NYLON GLASS
KH-RS-M8			

## 11PIN SOCKETS

MODEL		RATINGS	MATERIAL
KH-TDR-R11		250V 10A	PBT GLASS
KF-RS-R11			

# SIGNAL LIGHT



## KTL 40 L CFB - RYG - 3C D

① ② ③ ④ ⑤ ⑥

① DIAMETER	40	Ø40
	60	Ø60
② LAMP	L	LED
③ FUNCTIONS	NONE	Continuous only
	CF	Continuous & Flashing
	B	Buzzer
	CFB	Continuous, Flashing & Buzzer
④ LAMP COLOR	Red, Yellow, Green, Blue, Clear	
⑤ INPUT VOLTAGE	AC/DC 24V	
⑥ MOUNTING	D	Direct mount
	H	Upper bracket
	V	Wall mount bracket
	P	Pole mount

		KTL40L	KTL60L
INPUT VOLTAGE		AC/DC 24V	
CURRENT	LED(1 UNIT)	R, Y: 25mA	R, Y: 50mA
		G, B, W: 23mA	G, B, W: 25mA
	Buzzer	40mA	
	Power Supply	360mA	
Flashing Frequency		90/m	
Sound Pressure(1m)		75dB/m	

# SIGNAL LIGHT

## KH - 5030L - 24PCK

① ②

① MODEL	20L	20 x 20 mm
	30L	30 x 30 mm
	40L	40 x 40 mm
② INPUT VOLTAGE	12	12VDC
	14	24VDC
	12PCK	12VDC positive check input
	24PCK	24VDC positive check input
	DC110PCK	110VDC positive check input
	12NCK	12VDC negative check input
	24NCK	24VDC negative check input
	DC110NCK	110VDC negative check input
	12T	110VAC AC-DC converter
	22T	220VAC AC-DC converter

		KH-5020L	KH-5030L	KH-5040L
Panel unit size		20X20	30X30	30X40
Light Source		LED		
Current consumption		Max. 20mA		
Rated Voltage	Full Voltage	12V DC		
		24V DC		
Converter type	-	110 VAC		
	-	220 VAC		
Color		R,G,Y,O	R,G,Y,O,B,W	
Insulation resistance		100MΩ(DC500V)		
Dielectric Strength		AC 1,500v(50/60Hz)		
Ambient Temp.		-20~+65°C		
Material		Enclosure: PC, Color plate: Acryl, Reflector: Noryl		
Terminal		M2.5X7	M3.5X7	
Max. Combination	Column	13	20	20
	Row	13	20	20



# KFS Series - Floatless Switch



	100~110 VAC 200~220 VAC (50.60Hz)	COM-PACT
	100~110 VAC 200~220 VAC (50.60Hz)	NOR-MAL
	Electrode Fixing Unit	

HOIST SWITCH



POWER SWITCH



# KTM 3M - Timer

**KTM - 3M - □□**

TIME RANGE: 01S ~ 24H (0.1 Second ~ 24 Hours)

KTM-3M-Model

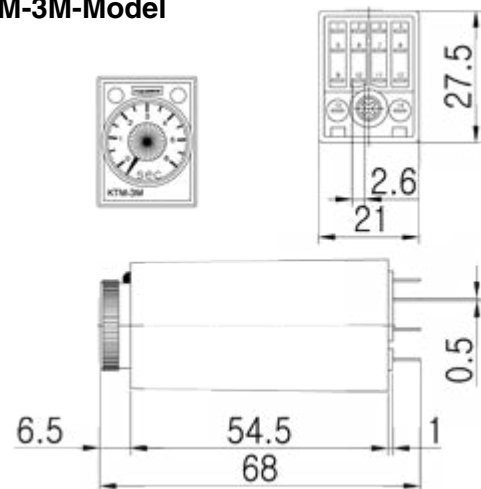

KTM-3M



CONTROL BOX



# SWITCH AND SENSOR



KunHung Electric Co., Ltd. established since 1969, is a leading professional manufacturer of industrial control equipment. With more than 42 years of experience in the industry, KunHung understands the needs and requirements of our customers, and we are striving for the highest level of customer service and satisfaction.

